



Araştırma Makalesi / Research Article

EFFECT OF FIBER ANGLE ON OUT-OF-PLANE AND IN-PLANE NATURAL FREQUENCIES OF LAMINATED COMPOSITE BEAMS

Mehmet ÇEVİK*

Dokuz Eylül University, İzmir Vocational School, Buca-İZMİR

Geliş/Received: 26.07.2007 Kabul/Accepted: 26.05.2008

ABSTRACT

Out-of-plane and in-plane free vibrations of angle-ply and cross-ply laminated composite beams with different boundary conditions are studied. The effect of fiber angle on out-of-plane bending, torsional, in-plane bending, and axial natural frequencies are investigated separately. The beam is modeled and analyzed by the finite element method (FEM). The finite element software package ANSYS is used to perform the numerical analyses using an eight-node layered shell element. The rotary inertia and shear deformation effects are taken into account. The method of solution is validated by comparing numerical results with those available in the literature. It has been shown that, by choosing angle-ply lamination instead of cross-ply, torsional, in-plane bending and axial natural frequencies can be increased by approximately 40%.

Keywords: Angle-ply laminated composite beam, natural frequency, finite element method.

PACS number/numarası: 46.40.-f, 46.70.De, 02.70.Dh.

TABAKALI KOMPOZİT KİRİŞLERİN DÜZLEM DIŞI VE DÜZLEM İÇİ DOĞAL FREKANSLARINA FİBER AÇISININ ETKİSİ

ÖZET

Farklı sınır şartlarına sahip açılı ve çapraz tabakalı kompozit kirişlerin düzlem içi ve düzlem dışı serbest titreşimleri incelenmiştir. Fiber açısının düzlem dışı eğilme, burulma, düzlem içi eğilme ve eksenel doğal frekanslara etkisi ayrı ayrı araştırılmıştır. Kiriş, sonlu eleman yöntemi kullanılarak modellenmiş ve analiz edilmiştir. Nümerik analizleri gerçekleştirmek için sekiz-düğümlü tabakalı kabuk eleman seçilerek sonlu eleman yazılım paketi ANSYS kullanılmıştır. Dönme ataleti ve kayma deformasyonu etkileri dikkate alınmıştır. Literatürde mevcut sayısal sonuçlar ile karşılaştırma yapılarak çözüm yöntemi doğrulanmıştır. Çapraz tabakalı yerine açılı tabakalı dizilişi tercih etmek suretiyle burulma, düzlem içi eğilme ve eksenel frekansların yaklaşık %40 arttırılabileceği gösterilmiştir.

Anahtar Sözcükler: Açılı tabakalı kompozit kiriş, doğal frekans, sonlu eleman yöntemi.

1. INTRODUCTION

Fiber reinforced composites are increasingly used in aerospace, automotive, marine, civil engineering and other industries. In the last few decades, research and development in composite materials have shown a tremendous increase. Fiber reinforced laminated composites constitute a

* e-mail/e-ileti: mehmet.cevik@deu.edu.tr, tel: (232) 420 09 08

significant part of these works. In many cases, metals are being replaced by laminated composites because of their superior advantages such as high strength-to-weight and stiffness-to-weight ratio.

There has been continued research interest in the vibration analysis of composite beams. Most of these studies are related with cross-ply laminated beams. Yıldırım et al. [1] used the transfer matrix method for the numerical solution of both in-plane and out-of-plane free vibration problems of symmetric cross-ply laminated composite beams. Rao et al. [2] developed an analytical method for evaluating the natural frequencies of laminated composite and sandwich beams using higher-order mixed theory and analyzed various beams of thin and thick sections. Maiti and Sinha [3] developed a finite element method (FEM) to analyze the vibration behavior of laminated composite beams and investigated the effects of various parameters. Matsunaga [4] analyzed natural frequencies and buckling stresses of general cross-ply laminated composite beams by taking into account the complete effects of transverse shear and normal stresses and rotary inertia. Khdeir and Reddy [5] studied free vibrations of cross-ply laminated beams with arbitrary boundary conditions. Murthy et al. [6] derived a refined 2-node beam element based on higher order shear deformation theory for axial-flexural-shear coupled deformation in asymmetrically stacked laminated composite beams. Ramtekkar et al. [7] developed a six-node plane-stress mixed finite element model by using Hamilton's principle. Natural frequencies of cross-ply laminated beams were obtained and various mode shapes were presented.

Although the research on the vibration analysis of laminated composite beams is mostly concentrated on cross-ply laminated composites, there are several studies on the vibration analysis of angle-ply laminated composite beams. Chandrashekhara et al. [8] presented exact solutions for the free vibration of symmetrically laminated composite beams, and demonstrated the effect of shear deformation, material anisotropy and boundary conditions on the natural frequencies. Bhimaraddi and Chandrashekhara [9] considered the modeling of laminated beams by a systematic reduction of the constitutive relations of the three-dimensional anisotropic body and concluded that these relations should be adopted while modeling especially angle-ply laminated composite beams. Chandrashekhara and Bangera [10] investigated the free vibration of angle-ply composite beams by a higher-order shear deformation theory using the shear flexible FEM. Krishnaswamy et al. [11] solved the generally layered composite beam vibration problems. Kadivar and Mohebpour [12] developed one-dimensional finite element based on classical lamination theory, and first- and higher-order shear deformation theories to study the dynamic response of cross-ply and angle-ply laminated beams. Chakraborty et al. [13] presented a refined locking free first-order shear deformable finite element and demonstrated its utility in solving free vibration and wave propagation problems in laminated composite beam structures with symmetric and asymmetric ply stacking. Chen et al. [14] presented a new method of state-space-based differential quadrature for free vibration of generally laminated beams. Tahani [15] developed two laminated beam theories for beams with general lamination including angle-ply laminated beams. Aydogdu [16] investigated the vibration analysis of angle-ply laminated beams subjected to different sets of boundary conditions based on a three-degrees-of-freedom shear deformable beam theory.

These studies deal mainly with the out-of-plane vibrations of angle-ply laminated beams. In the present study, however, both in-plane and out-of-plane coupled vibrations of angle-ply and cross-ply laminated composite beams with different boundary conditions are studied. The effect of fiber angle on out-of-plane bending, torsional, in-plane bending, and axial modes of vibrations is investigated separately. Frequencies of angle-ply and cross-ply laminations are compared. The beam is modeled and analyzed by the FEM. The rotary inertia and shear deformation effects are taken into account. The method of solution is validated by comparing numerical results with those available in the literature. The influence of material orthotropy, length-to-thickness and width-to-thickness ratios on the natural frequencies is also considered. Mode shapes for various modes are illustrated.

2. FINITE ELEMENT MODELING OF THE COMPOSITE BEAM

The geometry and coordinates of the laminated composite beam are illustrated in Fig. 1a and lamination of a typical 4-layered composite model is shown in Fig. 1b. The length, height (thickness) and width of the beam are represented by L , h and b , respectively. In order to simulate the out-of-plane bending, in-plane bending, torsional and axial vibrations of the beam, ANSYS 10.0 finite element analysis software package [17] is utilized. 8-noded, linear layered 3-dimensional structural shell element (shell 99) having six degrees of freedom at each node (translations in the nodal x , y , and z directions and rotations about the nodal x , y , and z -axes) is used for modeling. This element takes into account the rotary inertia and shear deformation effects. The frequencies are determined for clamped-clamped (C-C), clamped-hinged (C-H), clamped-free (C-F), and hinged-hinged (H-H) end conditions.

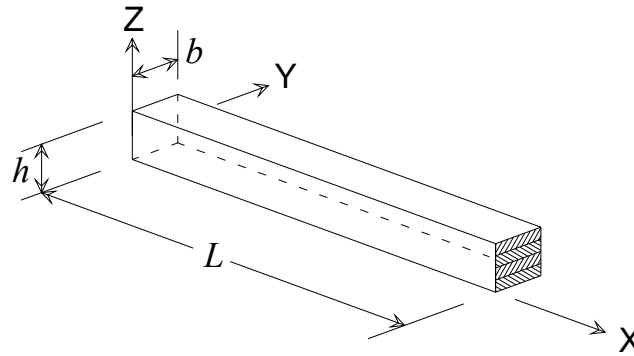

Figure 1a. Geometry and coordinates of the laminated composite beam.

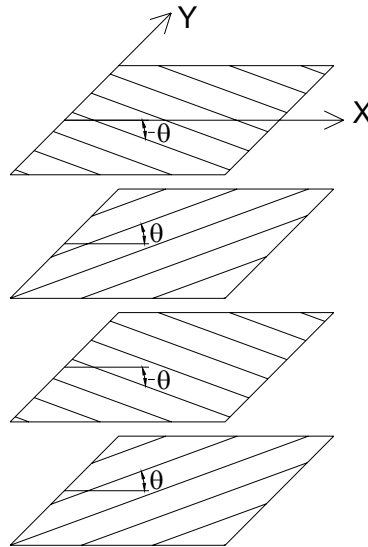

Figure 1b. Lamination of a typical 4-layered composite model.

3. VALIDATION OF THE MODEL

In order to validate the accuracy and applicability of the present model, numerical results are compared with those available in the literature. For this purpose, fundamental out-of-plane frequencies of a symmetric $[\theta/-\theta/-\theta/\theta]$ angle-ply laminated graphite-epoxy beam ($L/h=15, h/b=1$) are considered. The material properties are as follows: $E_1 = 144.8$ GPa, $E_2 = 9.65$ GPa, $G_{12} = G_{13} = 4.14$ GPa, $G_{23} = 3.45$ GPa, $\nu_{12} = 0.3, \rho = 1389.23$ Ns²/m⁴ where E, G and ν are the modulus of elasticity, shear modulus and Poisson's ratio, respectively. In Table 1, dimensionless natural frequencies $[\omega L^2(\rho/E_1 h^2)^{1/2}]$ of the beam are compared with the results from analytical methods [8,11], a semi-analytical state-space-based differential quadrature method (SSDQM) [14], first-order shear deformation theories [12] and refined higher-order shear deformation theory [16]. In FSDT-1, bend-torsion coupling and Poisson effect are not considered. In FSDT-2, bend-torsion coupling is considered but Poisson effect is neglected; and in FSDT-3, both bend-torsion coupling and Poisson effect are included. As seen from the table, the present model yielded results in good agreement with the results of [11], [14], [16], and FSDT-3, since it takes into account both bend-twist coupling and Poisson effect.

Table 1. Comparison of dimensionless frequencies of symmetric $[\theta/-\theta/-\theta/\theta]$ angle-ply beam

Boundary		Fiber-angle						
conditions	Theory	0°	15°	30°	45°	60°	75°	90°
C-C	Analytical [8]	4.8487	4.6635	4.0981	3.1843	2.1984	1.6815	1.6200
	Analytical [11]	4.869	3.988	2.878	1.947	1.644	1.621	1.631
	SSDQM [14]	4.8575	3.6484	2.3445	1.8383	1.6711	1.6161	1.6237
	FSDT-1 [12]	4.8712	4.6835	4.1118	3.1908	2.2006	1.6814	1.6207
	FSDT-2 [12]	4.8712	4.1071	3.3806	2.6199	1.9611	1.6604	1.6207
	FSDT-3 [12]	4.8629	4.0082	2.8762	1.9330	1.6290	1.6063	1.6161
	RHSdT [16]	4.973	4.294	2.195	1.929	1.669	1.612	1.619
	Present	4.8457	4.0455	2.9444	1.9974	1.6542	1.6110	1.6183
C-H	Analytical [8]	3.730	3.559	3.057	2.303	1.551	1.175	1.136
	Analytical [11]	3.837	3.243	2.213	1.388	1.146	1.129	1.131
	RHSdT[16]	3.775	2.960	1.671	1.178	1.150	1.122	1.129
	Present	3.7277	2.9881	2.0805	1.3787	1.1469	1.1238	1.1301

4. NUMERICAL RESULTS AND DISCUSSION

In this section, variation of dimensionless natural frequencies are analyzed and the effect of fiber angle on the natural frequencies is investigated. Unless stated otherwise, the orthotropic material properties of the composite layers are: $E_1/E_2 = 40, G_{12} = G_{13} = 0.6E_2, G_{23} = 0.5E_2, \nu_{12} = 0.25$. The frequencies are nondimensionalised as $[\omega L^2(\rho/E_2 h^2)^{1/2}]$.

4.1. Out-of-plane Vibrations

The variation of the lowest six out-of-plane frequencies of symmetric $[\theta/-\theta/-\theta/\theta]$ beams with respect to fiber angle for different boundary conditions is presented in Fig. 2. In symmetric

stacking sequences, out-of-plane bending modes are always coupled with torsional modes. The mode shapes change from flexural into torsional (or from torsional into flexural) where the frequency curves approach each other. (For example; in Fig 2a, 3rd and 4th modes at $\theta = 30^\circ$; 5th and 6th modes at $\theta = 10^\circ$). Taking into consideration this modal transition, it is noticed that out-of-plane bending frequency decreases, in general, as the fiber angle increases; whereas, torsional frequency increases up to about 25° fiber angle and then decreases gradually.

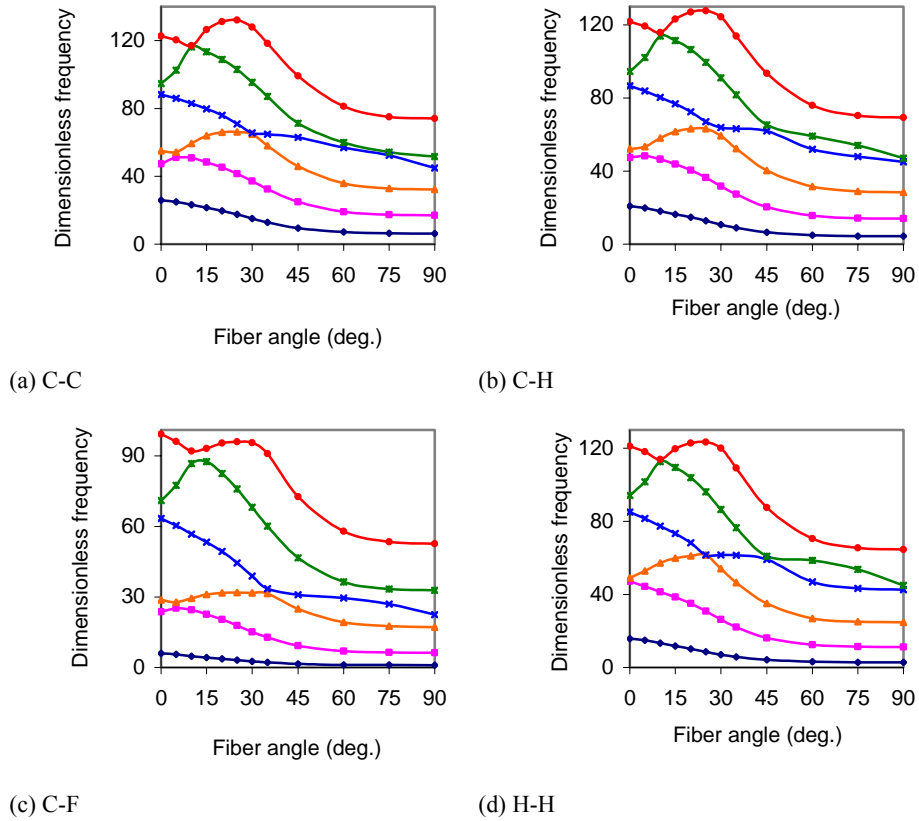
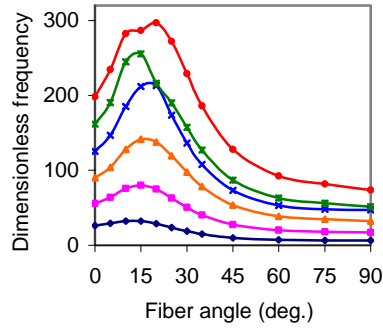

Figure 2. Variation of the lowest six out-of-plane frequencies with respect to fiber angle for different boundary conditions.

4.2. In-plane Vibrations

Fig. 3 shows the variation of the lowest six in-plane frequencies of symmetric $[0/-\theta/-\theta/0]$ beams with respect to fiber angle for different boundary conditions. In symmetric stacking sequences, nevertheless, in-plane bending modes and axial modes are always uncoupled. The variation is considerably different from that of out-of-plane frequencies. The in-plane bending frequency increases up to about 15° - 20° of fiber angle, reaches its maximum, and then decreases gradually up to 90° . This is more apparent in higher modes. The mode shapes change from flexural into axial (or from axial into flexural) where the frequency curves approach each other. Axial frequencies are determined for the purposes of this study. It is interesting that, unlike in-plane

bending frequencies, axial vibration frequencies result in a gradual decrease with increasing fiber angle.



(a) C-C

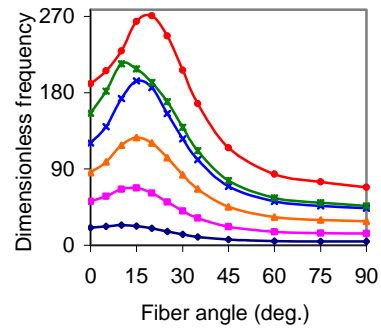

(b) C-H

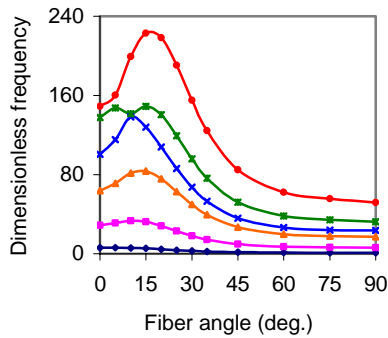

(c) C-F

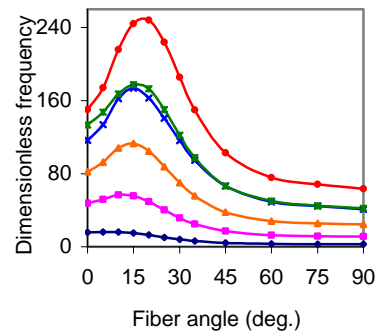

(d) H-H

Figure 3. Variation of the lowest six in-plane frequencies with respect to fiber angle for different boundary conditions.

4.3. Anti-symmetric Stacking Sequences

Unlike symmetric stacking sequences, coupling takes place between out-of-plane bending and in-plane bending modes in this case; that is, bending modes are uncoupled from torsional modes. It can further be noted that torsional modes are either uncoupled or coupled with axial modes. In Fig. 4, the first eight modes for $[30^\circ/-30^\circ/30^\circ/-30^\circ]$ anti-symmetric stacking sequence are shown. As seen from the figure, the fifth mode (e) is pure torsional and the seventh mode (g) is axial-torsional coupled mode; while the other six modes are out-of-plane bending and in-plane bending coupled modes. In Fig. 5, the variation of the lowest 11 frequencies with respect to fiber angle for anti-symmetric $[\theta/-\theta/\theta/-\theta]$ lamination under C-C boundary conditions is presented. The modal transitions where the frequency curves approach each other, are also apparent in Fig. 5. The variation of frequencies with respect to fiber angle is similar to that in symmetric stacking sequences.

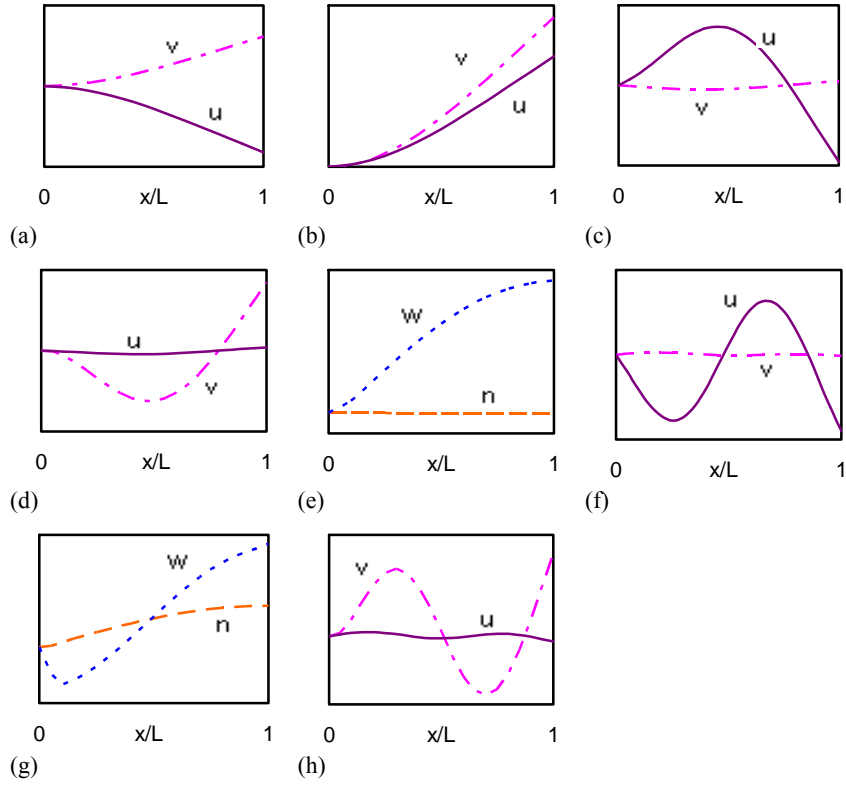

Figure 4. First eight modeshapes of anti-symmetric $[30^\circ/-30^\circ/30^\circ/-30^\circ]$ laminated beam.
 — out-of-plane bending (u) ; - - in-plane bending (v) ;
 torsional (w) ; - - axial vibrations (n)

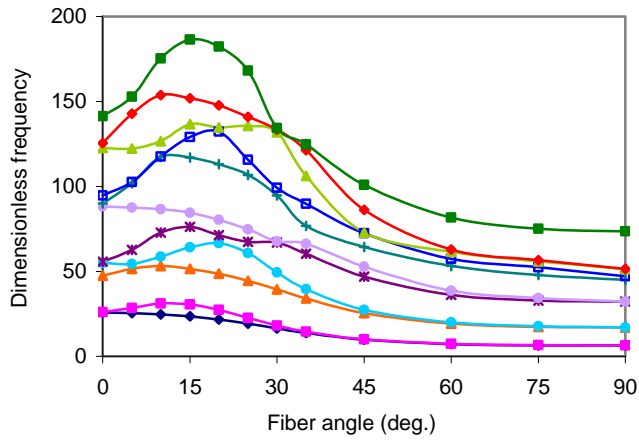

Figure 5. Variation of the lowest 11 frequencies with respect to fiber angle for anti-symmetric $[\theta/-\theta/\theta/-\theta]$ lamination under C-C boundary conditions.

Effect of Fiber Angle on Out-Of-Plane and In-Plane ...

Fig. 6 shows the effect of the width-to-thickness (b/h) ratio on the fundamental frequencies for C-C boundary conditions. It is seen that the dimensionless out-of-plane bending and axial frequencies decrease with increasing fiber angle, whereas b/h ratio has almost no effect on these modes. Fundamental torsional frequency becomes maximum at about 15°-30° fiber angle and decreasing b/h ratio increases torsional frequency. On the other hand, maximum in-plane bending frequencies occur at about 10°-15° and increasing b/h ratio increases in-plane bending frequency.

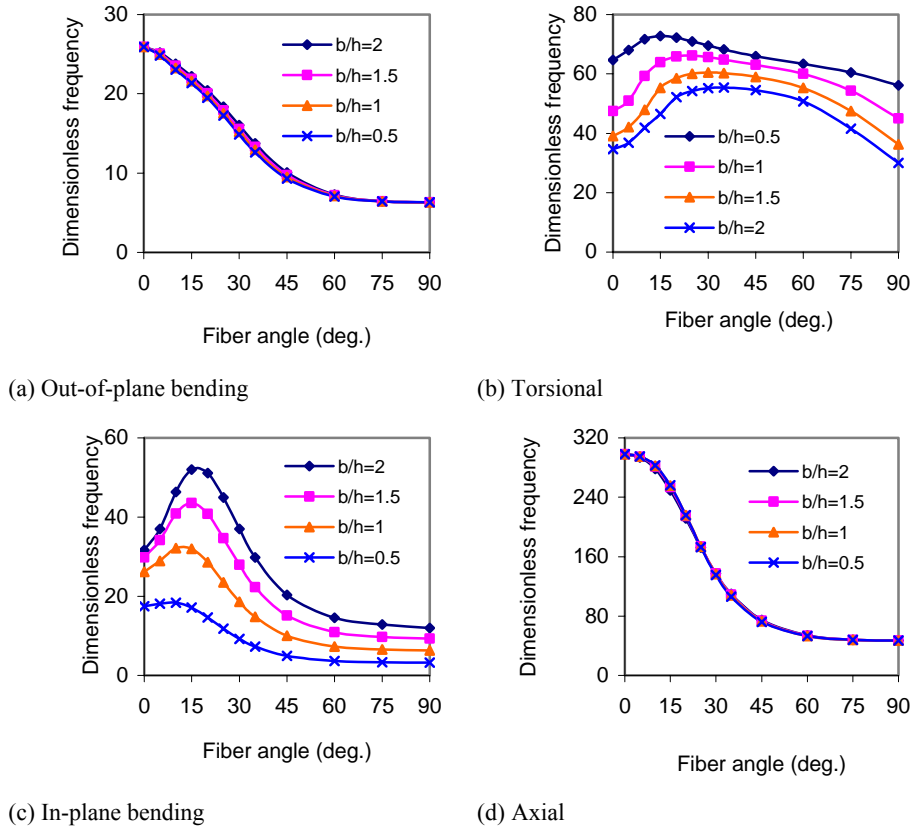
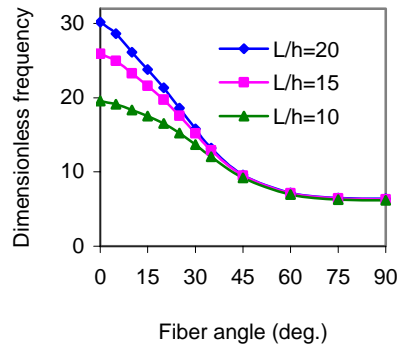
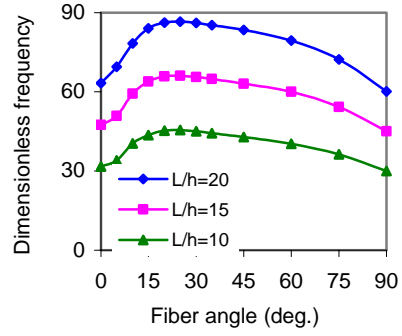

Figure 6. Effect of the b/h ratio on the fundamental frequencies for C-C boundary conditions.

Fig. 7 shows the effect of the length-to-thickness (L/h) ratio on the fundamental frequencies. Increasing L/h ratio increases fundamental dimensionless torsional and axial frequencies clearly. However, this ratio has almost no effect on dimensionless bending frequencies after 25°-35° fiber angle. Variation of frequencies with respect to fiber angle is as described already.



(a) Out-of-plane bending



(b) Torsional

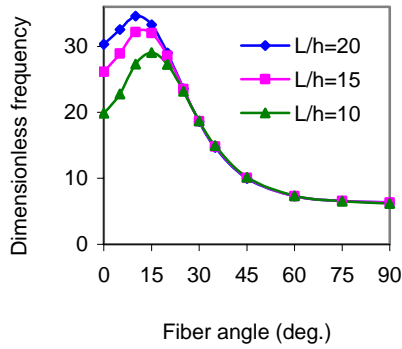

(c) In-plane bending

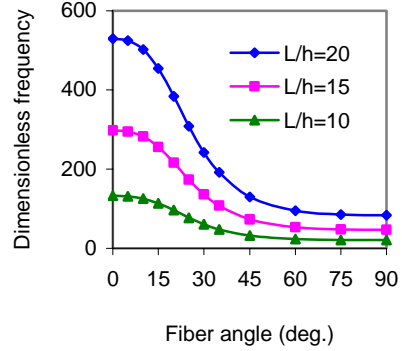

(d) Axial

Figure 7. Effect of the L/h ratio on the fundamental frequencies for C-C boundary conditions.

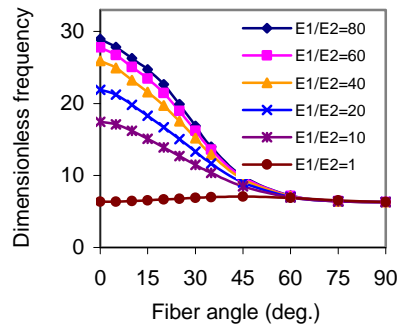

(a) Out-of-plane

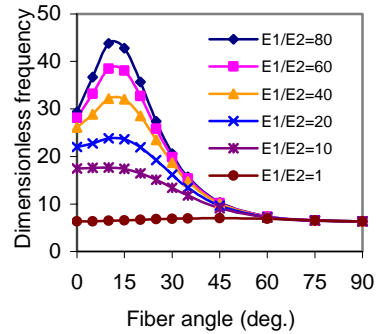

(b) In-plane

Figure 8. Effect of the ratio of the extensional modulus to the transverse modulus on the fundamental frequency for C-C boundary conditions.

Fig. 8 shows the effect of the ratio of the extensional modulus to the transverse modulus on the fundamental dimensionless out-of-plane and in-plane bending frequencies. The effect of fiber angle is more apparent at lower angles and it has no effect over 60°.

Fig. 9 illustrates the mode shapes of the fundamental out-of-plane bending, torsional, in-plane bending and axial modes of [30°/-30°/-30°/30°] laminated beam.

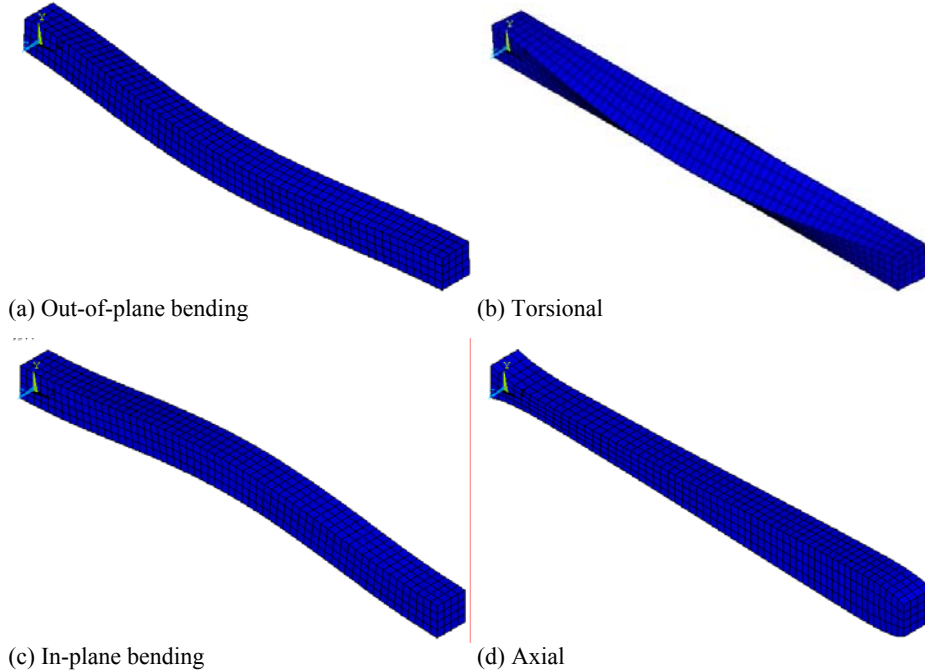

Figure 9. Mode shapes of the fundamental modes of [30°/-30°/-30°/30°] laminated beam

4.4. Comparison with cross-ply lamination

In order to make a comparison between cross-ply and angle-ply laminations, dimensionless fundamental frequencies of symmetric $[\theta/-\theta/-\theta/\theta]$ laminated composite beams are tabulated in Table 2 for different L/h ratios. In angle-ply beams, maximum out-of-plane bending and axial frequencies occur at 0° lamination, maximum in-plane bending frequency occurs at 10°-15° lamination, and maximum torsional frequency occurs at 25° lamination. It can be concluded from Table 2 that, by choosing angle-ply lamination instead of cross-ply, dimensionless torsional, in-plane bending and axial frequencies can be increased by approximately 40%. Angle-ply lamination provides no advantage in out-of-plane bending frequency.

According to the aim of use of the laminated composite beam, either cross-ply or angle-ply lamination should be preferred. For the beams subject to out-of-plane bending vibrations, cross-ply lamination is preferable; however, for those subject to in-plane bending or torsional vibrations angle-ply lamination result in higher natural frequencies; i.e. are more preferable. On the other hand, in order to avoid undesirable material coupling, either symmetric or anti-symmetric stacking sequences may be employed.

Table 2. Comparison of maximum dimensionless natural frequencies of angle-ply and cross-ply laminated beams

	Angle-ply			Cross-ply		
	$L/h=20$	$L/h=15$	$L/h=10$	$L/h=20$	$L/h=15$	$L/h=10$
Out-of-plane bending	30.167	25.902	19.561	28.554	24.590	18.638
Torsional	86.630	66.128	45.566	61.880	46.466	31.034
In-plane bending	34.609	32.162	29.059	24.543	22.138	17.912
Axial	529.800	298.013	132.450	379.582	213.515	94.895

5. CONCLUSIONS

The effects of fiber angle on the natural frequencies of laminated composite beams are investigated. Out-of-plane bending frequency always decreases as the fiber angle increases; whereas, torsional frequency increases up to about 25° fiber angle and then decreases gradually. The in-plane bending frequency increases up to about 15°-20° of fiber angle, reaches its maximum, and then decreases gradually up to 90°. This is more apparent in higher modes. In axial vibrations, however, frequencies result in a gradual decrease with increasing fiber angle. The mode shapes change from flexural into torsional or axial where the frequency curves approach each other. By choosing angle-ply lamination instead of cross-ply, dimensionless torsional, in-plane bending and axial natural frequencies can be increased by approximately 40%.

Acknowledgment

This study was supported by the Scientific and Technological Research Council of Turkey (TUBITAK) under project number 106M154.

REFERENCES

- [1] Yıldırım V., Sancaktar E., Kiral E., "Free vibration analysis of symmetric cross-ply laminated composite beams with the help of the transfer matrix approach", *Commun. Numer. Meth. Engng.*, 15, 9, 651-660, 1999.
- [2] Rao M.K., Desai Y.M., Chitnis M.R., "Free vibrations of laminated beams using mixed theory", *Compos. Struct.*, 52, 2, 149-160, 2001.
- [3] Maiti D.K., Sinha P.K., "Bending and free vibration analysis of shear deformable laminated composite beams by finite element method", *Compos. Struct.*, 29, 4, 421-431, 1994.
- [4] Matsunaga H., "Vibration and buckling of multilayered composite beams according to higher order deformation theories", *J. Sound Vibration.*, 246, 1, 47-62, 2001.
- [5] Khdeir A.A., Reddy J.N., "Free vibration of cross-ply laminated beams with arbitrary boundary conditions", *Int. J. Eng. Sci.*, 32, 12, 1971-1980, 1994.
- [6] Murthy M.V.V.S., Mahapatra D.R., Badarinarayana K., Gopalakrishnan S., "A refined higher order finite element for asymmetric composite beams", *Compos. Struct.*, 67, 1, 27-35, 2005.
- [7] Ramtekkar G.S., Desai Y.M., Shah A.H., "Natural vibrations of laminated composite beams by using mixed finite element modeling", *J. Sound Vibration.*, 257, 4, 635-651, 2002.

Effect of Fiber Angle on Out-Of-Plane and In-Plane ...

- [8] Chandrashekhara K., Krishnamurthy K., Roy S., "Free vibration of composite beams including rotary inertia and shear deformation", *Compos. Struct.*, 14, 4, 269-279, 1990.
- [9] Bhimaraddi A., Chandrashekhara K., "Some observations on the modeling of laminated composite beams with general lay-ups", *Compos. Struct.*, 19, 4, 371-380, 1991.
- [10] Chandrashekhara K., Bangera K.M., "Free vibration of composite beams using a refined shear flexible beam element", *Comput. Struct.*, 43, 4, 719-727, 1992.
- [11] Krishnaswamy S., Chandrashekhara K., Wu W.Z.B., "Analytical solutions to vibration of generally layered composite beams", *J. Sound Vibration.*, 159, 1, 85-99, 1992.